

COSORI®

User Manual

Pro LE 5.0-Quart Air Fryer

Model: CAF-L501-KUS

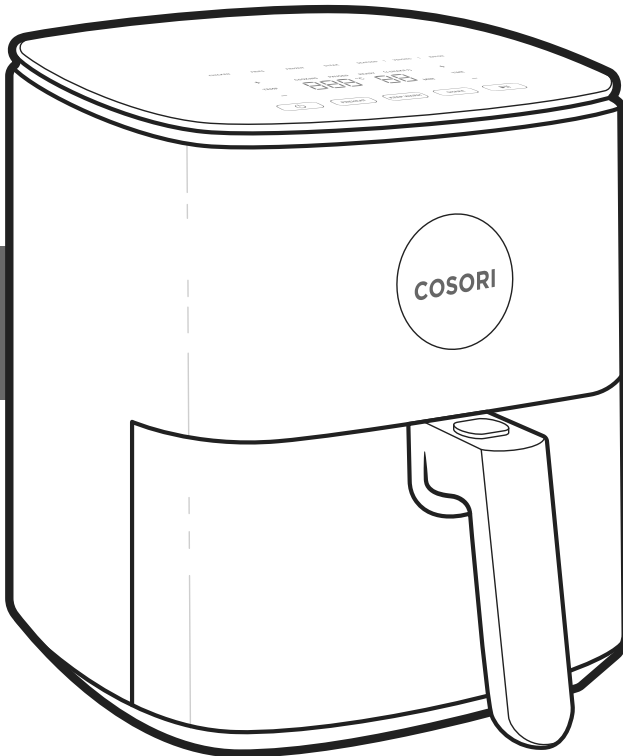

Questions or Concerns?

Mon–Fri, 9:00 am–5:00 pm PST/PDT
support@cosori.com | (888) 402-1684



Thank you for
your purchase!



(We hope you love your new air fryer as much as we do)



join

the Cosori Cooks Community on Facebook
[facebook.com/groups/cosoricooks](https://www.facebook.com/groups/cosoricooks)

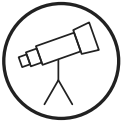

explore

our recipe gallery
www.cosori.com/recipes



enjoy

weekly, featured recipes
made exclusively by our in-house chefs



CONTACT OUR CHEFS

Our helpful, in-house chefs are ready to assist you with any questions you might have!

Email: recipes@cosori.com

Toll-Free: (888) 402-1684

Mon–Fri, 9:00 am–5:00 pm PST/PDT

On behalf of all of us at Cosori,

Happy cooking!

Table of Contents

Package Contents	3
Specifications	3
Important Safeguards	4
Getting to Know Your Air Fryer	7
Air Fryer Diagram	7
Display Messages	8
Before First Use	9
Using Your Air Fryer	10
Care & Maintenance	14
Troubleshooting	15
Warranty Information	16
Customer Support	17

Package Contents

- 1 x Pro LE 5.0-Quart Air Fryer
- 1 x Recipe Book
- 1 x User Manual

Specifications

Power Supply	AC 120V, 60Hz
Rated Power	1500W
Capacity	5.0 qt / 4.7 L (serves 2–4 people)
Temperature Range	170°–450°F / 77°–230°C
Time Range	1–60 min
Dimensions (Including Handle and Air Outlet Spacer)	12 x 10.8 x 14.4 in / 30.7 x 27.4 x 36.5 cm
Weight	10 lb / 4.54 kg

Download the free VeSync app to access original recipes and video tutorials from the Cosori chefs, interact with our online community, and more!



READ AND SAVE THESE INSTRUCTIONS

IMPORTANT SAFEGUARDS

Follow basic safety precautions when using your air fryer. Read all instructions.

Key Safety Points



- **Do not** touch hot surfaces. Use handle.
- Use caution when turning the basket over after cooking, as the hot crisper plate may fall out and create a safety hazard.
- **Do not** block any ventilation openings. Hot steam is released through openings. Keep your hands and face clear of openings.

General Safety

- To protect against electric shock, **do not** immerse the air fryer cord, plug, or housing in water or other liquids.
- Close supervision is necessary when the air fryer is used by or near children.
- Unplug when not in use, and before cleaning. Allow to cool before putting on or taking off parts.
- **Do not** use your air fryer if it has a damaged cord or plug, if it malfunctions, or if it has been damaged in any way. Contact **Customer Support** (see page 17).
- Using accessory attachments not recommended by Cosori may cause injuries.
- **Do not** use outdoors.

- **Do not** place the air fryer or any of its parts on a stove, near gas or electric burners, or in a heated oven.
- Be extremely cautious when moving your air fryer (or removing the basket) if it contains hot oil or other hot liquids.
- **Do not** clean with metal scouring pads. Metal fragments can break off the pad and touch electrical parts, creating a risk of electric shock.
- **Do not** use the air fryer for any purpose other than its intended use.
- **Do not** strike or hit the top of the air fryer with hard objects, as this may cause the tempered glass to crack. Tempered glass is stronger and fractures more safely than ordinary glass, but it may shatter unexpectedly after being cracked. If you see a crack, contact **Customer Support** (see page 17).
- This air fryer is not to be used by persons (including children) with reduced physical, sensory, or mental capabilities, or lack of experience and knowledge, unless they have been given supervision or instruction concerning use of the appliance by a person responsible for their safety.
- This air fryer is not intended to be operated by means of an external timer or separate remote-control system.
- Not for commercial use. Household use **only**.

While Air Frying

- An air fryer works with hot air **only**. **Never** fill the basket with oil or fat.
- **CAUTION:** To avoid risk of electric shock, cook **only** in the removable basket.
- To avoid risk of fire or electric shock, **do not** place oversized foods or metal utensils into your air fryer.
- **Do not** overfill the air fryer basket. Heaping amounts of food may touch the heating coils and cause a fire hazard.
- **Do not** touch accessories during or immediately after air frying.
- **Do not** place paper, cardboard, non-heat-resistant plastic, or similar materials, into your air fryer. You may use parchment paper or foil.
- **Never** put baking or parchment paper into the air fryer without food on top. Air circulation can cause paper to lift and touch heating coils.
- **Always** use heat-safe containers. Be extremely cautious if using containers that aren't metal or glass.
- To avoid risk of fire, **do not** cover or allow the air fryer to touch flammable materials (curtains, draperies, walls, etc.) when it is turned on.
- **Do not** store items on top of the air fryer when it is turned on.
- **Do not** store any materials other than Cosori's recommended accessories in the air fryer when not in use.
- Use on a flat, stable, heat-resistant surface away from heat sources or liquids.
- To turn the air fryer off, press  once. The air fryer will beep,  will turn blue, and other buttons will turn off.

- Immediately turn off and unplug your air fryer if you see dark smoke coming out. White smoke is normal, caused by heating fat or food splashing, but dark smoke means that food is burning or there is a circuit problem. Wait for smoke to clear before pulling the basket out. If the cause was not burnt food, contact **Customer Support** (page 17).
- **Do not** leave your air fryer unattended while in use.

Power & Cord

- Your air fryer has a polarized plug (one prong is wider than the other), which fits into a polarized outlet only one way. If the plug does not fit, reverse the plug. If it still does not fit, **do not** use the plug in that outlet. **Do not** alter the plug in any way.
- **Do not** let the power cord (or any extension cord) hang over the edge of a table or counter, or touch hot surfaces.
- Remove and discard the protective cover fitted over the power plug of the air fryer to prevent choking hazards.
- **Never** use an outlet below the counter when plugging in your air fryer.
- Keep the air fryer and its cord out of reach of children less than 8 years old.
- Your air fryer should **only** be used with **120V, 60Hz** electrical systems. **Do not** plug into another type of outlet.

Extension Cords

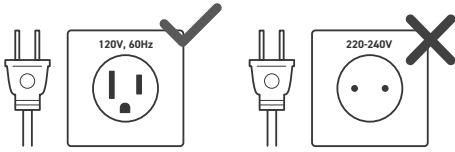

- A short power-supply cord is provided to reduce the risk resulting from becoming entangled in or tripping over a longer cord.
- Longer extension cords are available and may be used if care is exercised in their use. If a longer extension cord is used:
 - The marked electrical rating of the extension cord should be at least as great as the electrical rating of the air fryer.
 - The cord should be arranged so that it will not drape over the countertop or tabletop where it can be pulled on by children or tripped over unintentionally.
- If the power supply cord is damaged, it must be replaced by Arovast Corporation or similarly qualified persons in order to avoid an electric or fire hazard. Please contact **Customer Support** (page 17).

Electromagnetic Fields (EMF)

The Cosori Air Fryer complies with all standards regarding electromagnetic fields (EMF). If handled properly and according to the instructions in this user manual, the appliance is safe to use based on scientific evidence available today.



Caution: Hot surface.

SAVE THESE INSTRUCTIONS

GETTING TO KNOW YOUR AIR FRYER

Your Cosori Air Fryer uses rapid 360° air circulation technology to cook with little to no oil for quick, crispy, delicious food with up to 85% fewer calories than deep fryers. With user-friendly, one-touch controls, a nonstick basket, and an intuitive, safe design, the Cosori Air Fryer is the star of your kitchen.

Note:

- **Do not** try to open the top of the air fryer. This is not a lid.
- The basket and crisper plate are made of aluminium metal with nonstick coating.

Air Fryer Diagram

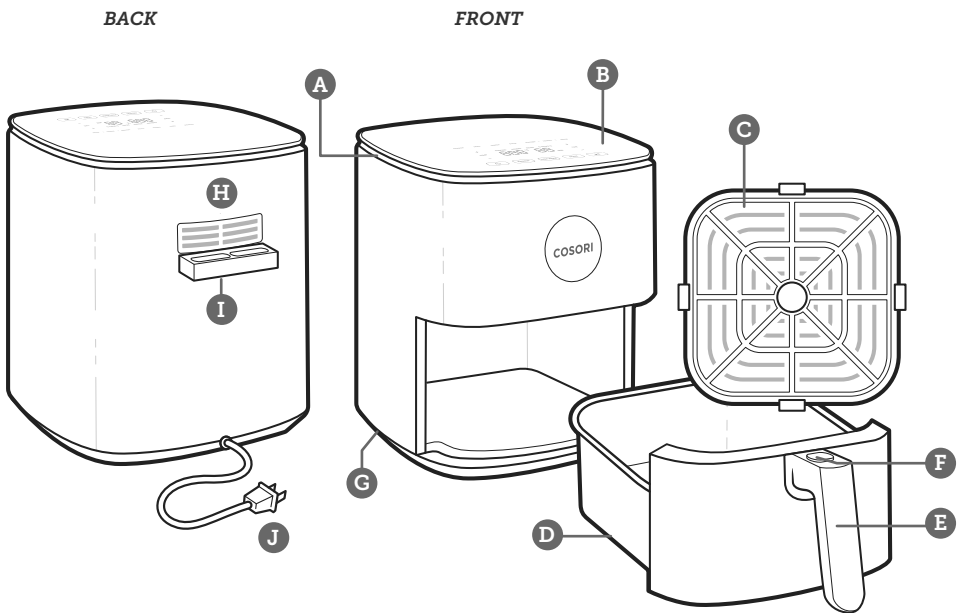

- | | | |
|-------------------|--------------------------|----------------------|
| A. Air Inlet | E. Basket Handle | I. Air Outlet Spacer |
| B. Control Screen | F. Basket Release Button | J. Power Cord |
| C. Crisper Plate | G. Housing Handles | |
| D. Basket | H. Air Outlet | |

Display Diagram

Note: When you press a button to use a function or program, it will turn white to show that it's active.

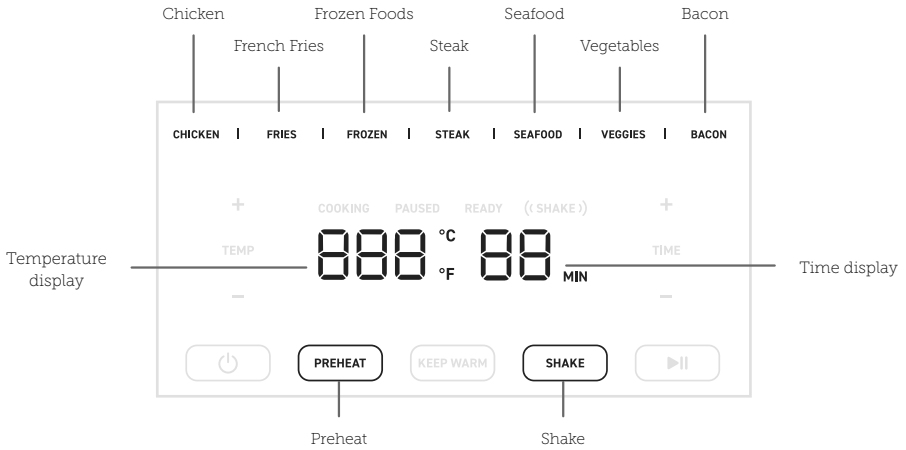

Note: This turns the Shake Reminder on/off.

Control Panel

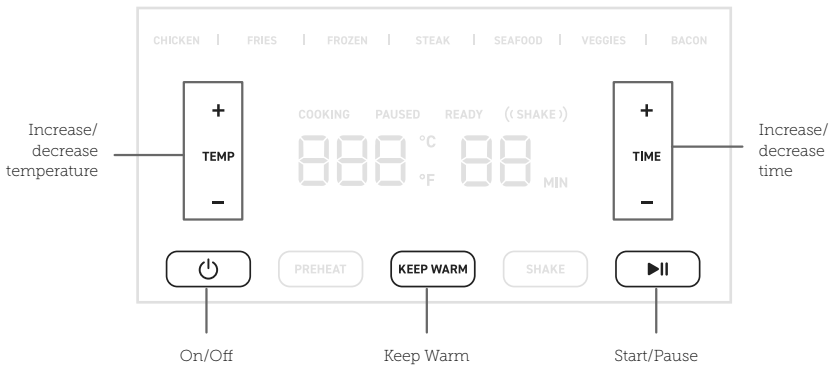

Display Messages

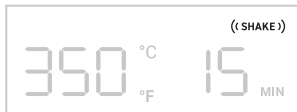

Reminder to shake or flip food

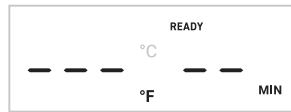

Air fryer is preheated and ready to start cooking

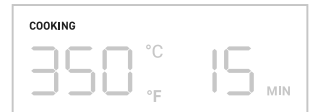

Air fryer is cooking

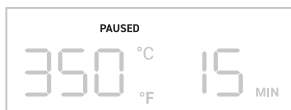

Cooking is paused

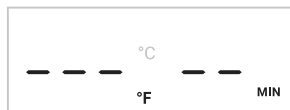

Cooking program has ended

BEFORE FIRST USE

Setting Up

1. Remove all packaging from the air fryer, including any temporary stickers.
2. Place the air fryer on a stable, level, heat-resistant surface. Keep away from areas that can be damaged by steam (such as walls or cupboards).

Note: Leave 5 inches / 13 cm of space behind and above the air fryer. **[Figure 1.1]** Leave enough room in front of the air fryer to remove the basket.

3. Hold down the basket release button, and pull the handle to remove the basket. Remove all plastic from the basket.
4. Wash both the basket and crisper plate thoroughly, using either a dishwasher or a non-abrasive sponge.
5. Wipe the inside and outside of the air fryer with a slightly moist cloth. Dry with a towel.
6. Insert the crisper plate back into the basket, and place the basket inside the air fryer.

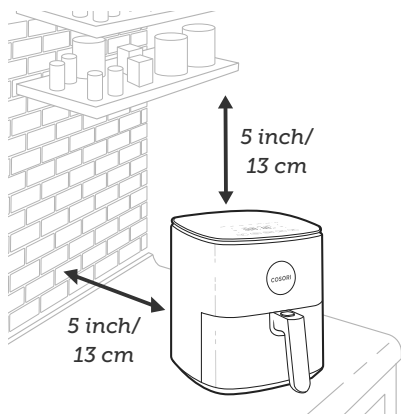

Figure 1.1

Test Run

A test run will help you become familiar with your air fryer, make sure it's working correctly, and clean it of possible residues in the process.

1. Make sure the air fryer basket is empty and plug in the air fryer.
2. Press **PREHEAT**. The display will show "400°F" and "4 MIN".
3. Press **▶||** to begin preheating. When preheating is done, the air fryer will beep.
4. Pull out the basket and let it cool for 4 minutes. Then place the basket back into the air fryer.
5. Press **STEAK** to select the **Steak** function. The display will show "450°F" and "6 MIN".
6. Press **TIME** once. The time will change to 5 minutes.
7. Press **▶||** to begin. When finished, the air fryer will beep.
8. Remove the basket. This time, let the basket cool completely for 10–30 minutes.

Note:

- Use caution when turning the basket over after cooking, as the hot crisper plate may fall out and create a safety hazard.
- **Do not** unscrew the basket handle from the basket.

Rubber Stoppers

- The crisper plate contains 4 rubber stoppers made of safe, FDA-approved material. These stoppers keep the crisper plate fitted to the bottom of the basket, prevent the crisper plate from directly touching the basket, and in rare cases, damaging the nonstick coating on the basket.
- **Only** remove the rubber stoppers for cleaning purposes. For easy removal, start from the bottom of the crisper plate and pull out one side of the stopper at a time. [Figure 1.2]
- To place the rubber stoppers back onto the crisper plate, first soak them in water. Then, push each stopper back in through the bottom of the crisper plate. Push in one side of the stopper at a time.

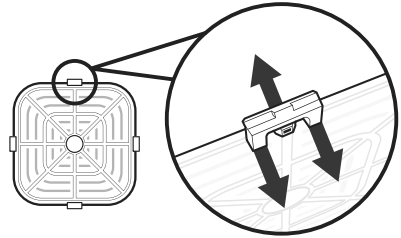



Figure 1.2

USING YOUR AIR FRYER

Preheating

We recommend preheating before placing food inside the air fryer, unless your air fryer is already hot. Food will not cook thoroughly without preheating.

1. Plug in. Press  to turn on the air fryer display.
2. Press **PREHEAT**. The display will show "400°F" and "4 MIN".
3. Optionally, press the + or – buttons to change the temperature. The time will adjust automatically.
4. Press  to begin preheating.
5. When preheating is done, the air fryer will beep 3 times. The display will show the set preheat temperature. [Figure 2.1]

Temperature	Time
400°–450°F / 205°–230°C	4 minutes
290°–390°F / 143°–199°C	3 minutes
170°–280°F / 77°–140°C	2 minutes

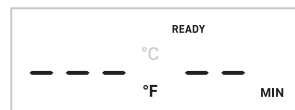

Figure 2.1

Note: If no buttons are pressed for 3 minutes, the air fryer will clear all settings and go into standby.

Air Frying

Note:

- **Do not** place anything on top of your air fryer. This may interfere with your cooking program or cause cracks in the glass on the display. [Figure 2.1]
- An air fryer is not a deep fryer. **Do not** fill the basket with oil, frying fat, or any liquid.
- When taking the basket out of the air fryer, be careful of hot steam.

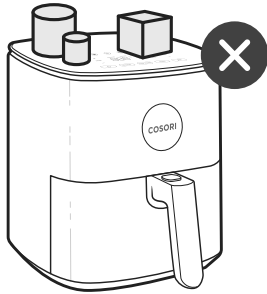

Figure 2.1

Cooking Functions

Using a cooking function is the easiest way to air fry. Cooking functions are programmed with an ideal time and temperature for cooking certain foods.

1. Press the function's button to select the function. The air fryer will automatically change to the function's default settings.
2. You can change a function's time (1–60 minutes), temperature (170°–450°F), and Shake Reminder.
3. Press and hold the + or – button to rapidly increase or decrease the time or temperature.
4. Add or remove a Shake Reminder by pressing **SHAKE**.
5. To go back to a function's default settings, press the function's button again.

Note: Results may vary. Check out our *Recipe Book* for a guide to using cooking functions for perfect results.

Function	Default Temperature	Default Time (minutes)	Shake Reminder?*
Chicken	380°F/193°C	20 minutes	-
French Fries**	380°F/193°C	25 minutes	((SHAKE))
Frozen Foods	350°F/177°C	10 minutes	-
Steak	450°F/230°C	6 minutes	-
Seafood	350°F/177°C	8 minutes	((SHAKE))
Veggies	350°F/177°C	10 minutes	((SHAKE))
Bacon	320°F/160°C	8 minutes	-
Preheat	400°F/205°C	4 minutes	-
Keep Warm	170°F/77°C	5 minutes	-

* See **Shaking Food** (page 12).

** See **Cooking Guide** (page 13) for more tips on air frying French fries.

Air Frying

1. **Preheat your air fryer** (see page 10).
2. When your air fryer displays **READY**, add food to the basket.
 - For the best results, add the crisper plate into the basket to allow excess oil to drip down to the bottom of the basket.
3. Select a cooking function (see page 11).

Note: *Cooking functions are programmed with an ideal time and temperature for cooking certain foods. You can also set a custom time and temperature without choosing a cooking function.*

4. Optionally, change the temperature and time, and add a Shake Reminder. You can do this anytime during cooking.
 - a. Press the **+** or **-** buttons to change the temperature (170°–450°F / 77°–230°C) or time (1–60 minutes).

Note:

- To rapidly increase or decrease time or temperature, press and hold the **+** or **-** buttons.
 - Press **SHAKE** to add or remove a Shake Reminder during cooking.
5. Press **▶||** to begin air frying.
 6. When the Shake Reminder is turned on, it will appear halfway through cooking time. The air fryer will beep 5 times, and **(SHAKE)** will blink on the display.
 - a. Press the basket release button to take the basket out of the air fryer, being careful of hot steam. The air fryer will pause cooking automatically, and the display will turn off until the basket is replaced.
 - b. Shake or flip the food.
 - c. Put the basket back into the air fryer.

Note: See **Shaking Food** (page 12)

7. The air fryer will beep 3 times when finished. The display will show:

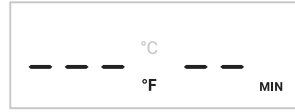

8. Optionally, press **KEEP WARM**. Press the **+** or **-** buttons to change the time (1–60 minutes).
9. Press the basket release button to take the basket out of the air fryer, being careful of hot steam.
10. Allow to cool before cleaning.

Shaking Food

How to Shake

- During cooking, press and hold the basket release button to take the basket out of the air fryer, and shake, mix, or flip the food.
 - a. To shake food:
 1. Hold the basket just above a heat-resistant surface for safety purposes.
 2. Shake the basket.
- Note:** *Do not use this method if there is a risk of hot liquids splashing.*
- b. If the basket is too heavy to shake and there are hot liquids present:
 1. Place the basket on a heat-resistant holder or surface.
 2. Use tongs to mix or flip the food.
- When you take the basket out, the air fryer will pause cooking automatically. As a safety feature, the display will turn off until the basket is replaced.

- When you replace the basket, cooking will automatically resume.
- Avoid shaking longer than 30 seconds, as the air fryer may start to cool down.

What to Shake

- Small foods that are stacked will usually need shaking, such as fries or nuggets.
- Without shaking, foods may not be crispy or evenly cooked.
- You can flip other foods, such as steak, to ensure even browning.

When to Shake

- Shake or flip food once halfway through cooking, or more if desired.
- The Shake Reminder is designed to remind you to check on your food. Tap **SHAKE** to turn on the Shake Reminder. Certain cooking functions use the Shake Reminder automatically (see **Cooking Functions**, page 11).

Shake Reminder

- The Shake Reminder will alert you with 5 beeps, and **(SHAKE)** will blink on the display.
- If you do not remove the basket, the Shake Reminder will beep again after 1 minute and the display will show a solid **(SHAKE)**.
- The Shake Reminder will go away once you take out the basket.

Cooking Guide

Overfilling

- If the basket is overfilled, food will cook unevenly.

Using Oil

- Adding a small amount of oil to your food will make it crispier. Use no more than 2 US tbsp / 30 mL of oil.
- Oil sprays are excellent for applying small amounts of oil evenly to all food items.

Food Tips

- You can air fry any frozen foods or goods that can be baked in an oven.
- To make cakes, hand pies, or any food with filling or batter, place food in a heat-safe container before placing in the basket.
- Air frying high-fat foods will cause fat to drip to the bottom of the basket. To avoid excess smoke while cooking, pour out fat drippings after cooking.
- Liquid-marinated foods create splatter and excess smoke. Pat these foods dry before air frying.

French Fries

- Add ½–1 US tbsp / 8–15 mL oil for crispiness.
- When making fries from raw potatoes, soak uncooked fries in water for 15 minutes to remove starch prior to frying. Pat dry with a towel before adding oil.
- Cut uncooked fries smaller for crispier results. Try cutting fries into ¼- by 3-inch / 0.6- by 7.6-cm strips.

Note: For more from the Cosori Kitchen, check out our *Recipe Book* and *Tips from the Chef*.

More Functions

Switching Temperature Units

1. Press and hold **TEMP** (“+” and “–”) for 3 seconds.
2. The temperature unit will change from Fahrenheit to Celsius.
3. Repeat to switch back to Fahrenheit.

Pausing

1. Press **▶||** to pause cooking. The air fryer will stop heating, and **▶||** will turn blue until you press **▶||** to resume cooking.

2. After 30 minutes of inactivity, the air fryer will turn off.
3. This function allows you to pause the cooking program without removing the basket from the air fryer.

Automatically Resume Cooking

- If you pull out the basket, the air fryer will pause cooking automatically. The display will turn off temporarily as a safety feature.
- When you return the basket, the air fryer will automatically resume cooking based on your previous settings.

Automatically Shutoff

- If the air fryer has no active cooking programs, the air fryer will clear all settings and turn off after 3 minutes of inactivity.

Overheat Protection

- If the air fryer overheats, it will automatically shut down as a safety feature.
- Let the air fryer cool down completely before using it again.

CARE & MAINTENANCE

Note:

- **Always** clean the air fryer basket and crisper plate after every use.
 - Lining the basket with foil (except the crisper plate) may make cleanup easier.
1. Turn off and unplug the air fryer. Allow it to cool completely before cleaning. Pull out the basket for faster cooling.
 2. Wipe the outside of the air fryer with a moist cloth, if necessary.
 3. The basket and crisper plate are dishwasher safe. You can also wash the basket and crisper plate with hot, soapy water and a non-abrasive sponge. Soak if necessary.

Note: The basket and crisper plate have a nonstick coating. Avoid using metal utensils and abrasive cleaning materials.

4. For stubborn grease:
 - a. In a small bowl, mix 2 US tbsp / 30 mL of baking soda and 1 US tbsp / 15 mL of water to form a spreadable paste.

- b. Use a sponge to spread the paste on the basket and crisper plate and scrub. Let the basket and crisper plate sit for 15 minutes before rinsing.
 - c. Wash basket with soap and water before using.
5. Clean the inside of the air fryer with a slightly moist, non-abrasive sponge or cloth. **Do not** immerse in water. [Figure 3.1] If needed, clean the heating coil to remove food debris.
 6. Dry before using.

Note: Make sure the heating coil is completely dry before turning on the air fryer.

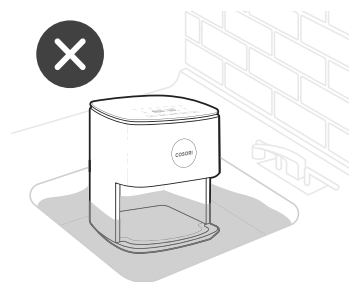

Figure 3.1

TROUBLESHOOTING

Problem	Possible Solution
The air fryer will not turn on.	Make sure the air fryer is plugged in.
	Push the basket securely into the air fryer.
Foods are not completely cooked.	Place smaller batches of food items into the basket. If the basket is overstuffed, then foods will be undercooked.
	Increase cooking temperature or time.
Foods are cooked unevenly.	Foods that are stacked on top of each other or close to each other need to be shaken or flipped during cooking (see Shaking Food , page 12).
Foods are not crispy after air frying.	Spraying or brushing a small amount of oil on foods can increase crispiness (see Cooking Guide , page 13).
French fries are not cooked correctly.	See French Fries , page 13.
Basket will not slide into the air fryer securely.	Make sure the basket is not overfilled with food.
White smoke or steam is coming out of the air fryer.	The air fryer may produce some white smoke or steam when you use it for the first time or during cooking. This is normal.
	Make sure the basket and the inside of the air fryer are cleaned properly and not greasy.
	Cooking greasy foods will cause oil to collect beneath the crisper plate. This oil will produce white smoke, and the basket may be hotter than usual. This is normal, and should not affect cooking. Handle the basket with care.
Dark smoke is coming out of the air fryer.	Immediately unplug your air fryer. Dark smoke means that food is burning or there is a circuit problem. Wait for smoke to clear before pulling the basket out. If the cause was not burnt food, contact Customer Support (page 17).
The air fryer has a plastic smell.	Any air fryer may have a plastic smell from the manufacturing process. This is normal. Follow the instructions for a Test Run (page 9) to get rid of the plastic smell. If a plastic smell is still present, please contact Customer Support (see page 17).
Display shows Error Code "E1".	There is an open circuit in the temperature monitor. Contact Customer Support (see page 17).
Display shows Error Code "E2".	There is a short circuit in the temperature monitor. Contact Customer Support (see page 17).
Display shows Error Code "E3".	The air fryer's overheat protection has activated. Turn off and unplug the air fryer and allow it to cool completely. If the display continues to show "E3", contact Customer Support (see page 17).
Display shows Error Code "E4".	The air fryer has been plugged into a 220–240V outlet. Turn off and unplug the air fryer. Only use the air fryer with 120V, 60Hz outlets.

If your problem is not listed, please contact **Customer Support** (see page 17).

WARRANTY INFORMATION

Product Name	Pro LE 5.0-Quart Air Fryer
Model	CAF-L501-KUS
<i>For your own reference, we strongly recommend that you record your order ID and date of purchase.</i>	
Date of Purchase	
Order ID	

TERMS & POLICY

Arovast Corporation (“Arovast”) warrants this product to the original purchaser to be free from defects in material and workmanship, under normal use and conditions, for a period of 2 years from the date of original purchase.

Arovast agrees, at our option during the warranty period, to repair any defect in material or workmanship or furnish an equal product in exchange without charge, subject to verification of the defect or malfunction and proof of the date of purchase.

There is no other express warranty. This warranty does not apply:

- If the product has been modified from its original condition;
- If the product has not been used in accordance with directions and instructions in the user manual;
- To damages or defects caused by accident, abuse, misuse or improper or inadequate maintenance;
- To damages or defects caused by service or repair of the product performed by an unauthorized service provider or by anyone other than Arovast;
- To damages or defects occurring during commercial use, rental use, or any use for which the product is not intended;
- To damages or defects exceeding the cost of the product.

Arovast will not be liable for indirect, incidental, or consequential damages in connection with the use of the product covered by this warranty.

This warranty extends only to the original consumer purchaser of the product and is not transferable to any subsequent owner of the product regardless of whether the product is transferred during the specified term of the warranty.

This warranty does not extend to products purchased from unauthorized sellers. Arovast’s warranty extends only to products purchased from authorized sellers that are subject to Arovast’s quality controls and have agreed to follow its quality controls.

ALL IMPLIED WARRANTIES ARE LIMITED TO THE PERIOD OF THIS LIMITED WARRANTY.

This warranty gives you specific legal rights and you may also have other rights which vary from state to state. Some states do not allow the exclusion or limitation of incidental or consequential damages, so the above limitation or exclusion may not apply to you.

If you discover that your product is defective within the specified warranty period, please contact Customer Support via support@cosori.com. **DO NOT** dispose of your product before contacting us. Once our Customer Support Team has approved your request, please return the product with a copy of the invoice and order ID.

Every Cosori product automatically includes a 2-year warranty. To make the customer support process quick and easy, register your product online at www.cosori.com/warranty.

This warranty is made by:

Arovast Corporation
1202 N. Miller St., Suite A
Anaheim, CA 92806

CUSTOMER SUPPORT

If you have any questions or concerns about your new product, please contact our helpful Customer Support Team.

Arovast Corporation

1202 N. Miller St., Suite A
Anaheim, CA 92806

Email: support@cosori.com

Toll-Free: (888) 402-1684

Support Hours

Mon–Fri, 9:00 am–5:00 pm PST/PDT

**Please have your invoice and order ID ready before contacting Customer Support.*

COSORI®

Questions or Concerns?

Mon-Fri, 9:00 am-5:00 pm PST/PDT
support@cosori.com | (888) 402-1684